

## **How to convert a CSV to Pocket Excel Format on your PDA**

This document explains how to convert a CSV log file into the Pocket Excel format so that it can be viewed on your PDA.

This is achieved using a shareware application called PXLCSV developed by TascalSoft. The program can be downloaded and registered using the link below;

[http://www2r.biglobe.ne.jp/~tascal/download/pocketpc/pxlcsv\\_e.htm](http://www2r.biglobe.ne.jp/~tascal/download/pocketpc/pxlcsv_e.htm)

Once the application is installed follow this procedure.

Start PXLCSV

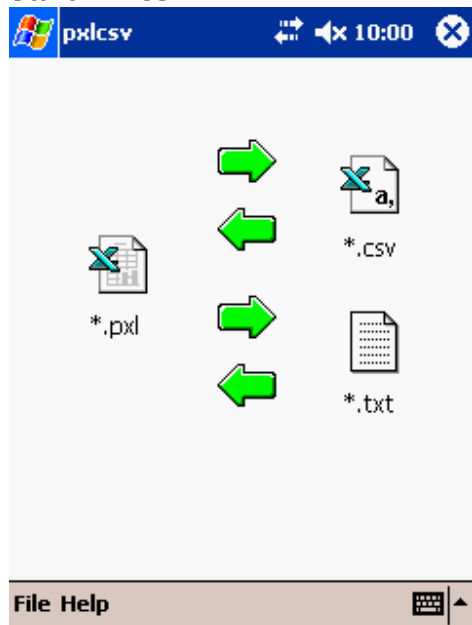

Tap "File" menu option and select the "Conv(CSV->PXL)" option

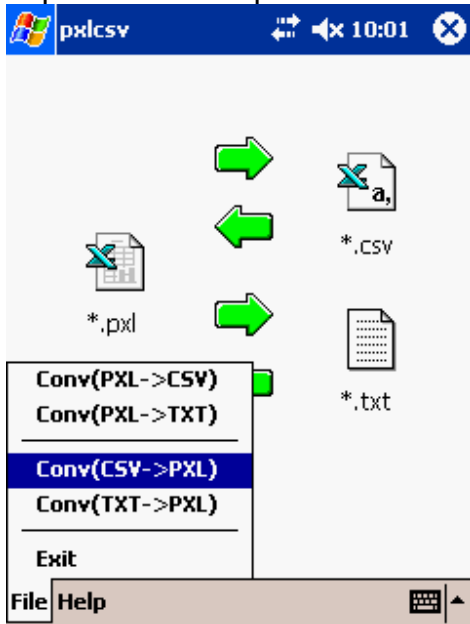

A file browser dialog will appear, select the CSV file you wish to convert and press "ok"

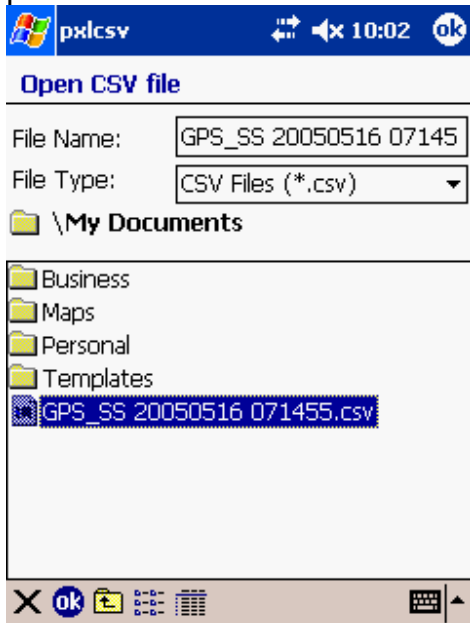

A warning will come up if the program is not registered, if you use the software you should register it. Press "ok" to dismiss the warning.

The application will now ask for the PXL name, type a name and press "ok"

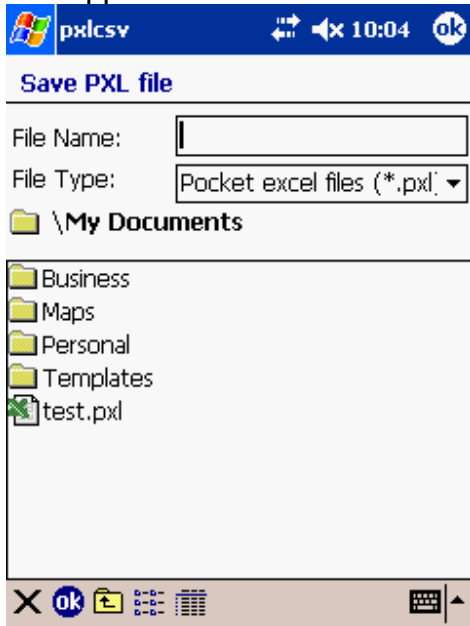

The file will then be converted and a message will be displayed when the conversion is complete

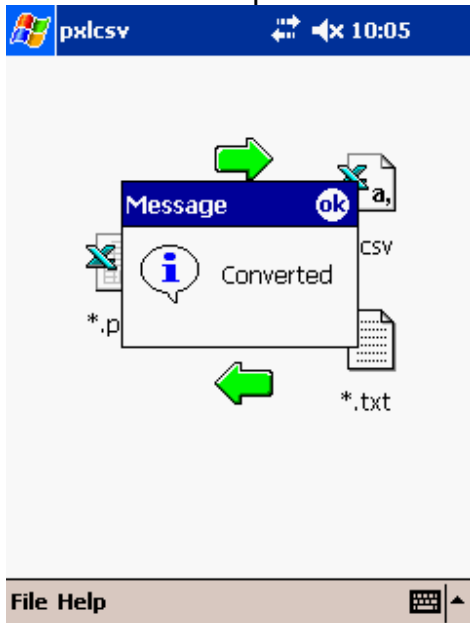

Now open Pocket Excel and the file should be available to view

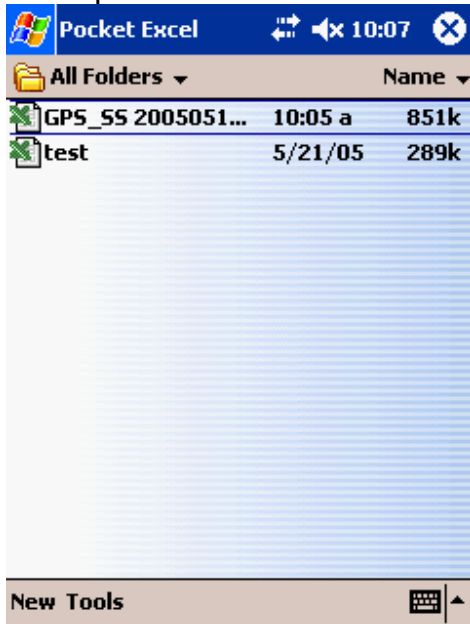

Tap the file to open it in Pocket Excel

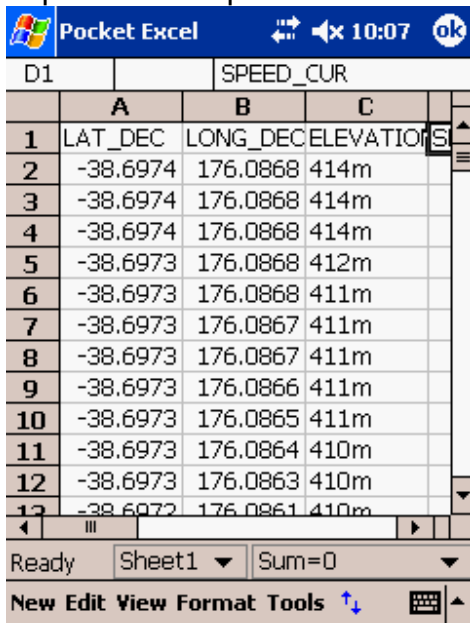

The CSV file is now in Pocket Excel format.